

Activity 9

Name(s) _____

Classifying Wallpaper Patterns

In this activity, you will classify wallpaper patterns. Mathematically speaking, *wallpaper patterns* are patterns that extend forever in both the horizontal and the vertical direction. Although infinitely many different wallpaper designs are possible, mathematicians have shown that there are exactly 17 different types of wallpaper patterns if they are classified by their symmetries. Each type of pattern has a code that is made up of two to four characters. Use the flow chart on this page to identify types and assign codes to the patterns on the next page.

Wallpaper-Pattern Classification Flow Chart

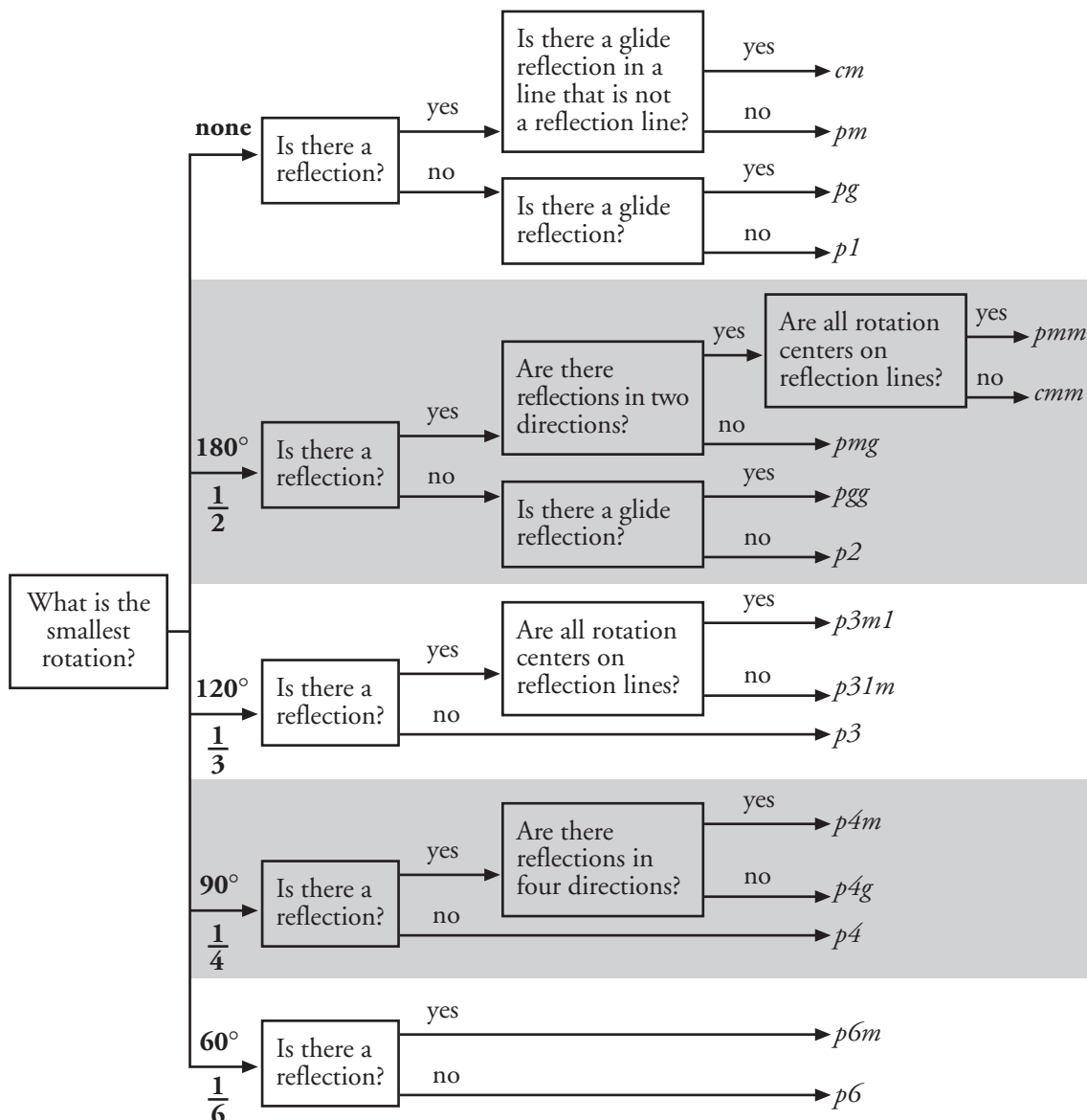

Activity 9 (continued)

Name(s) _____

Q1 Code: _____

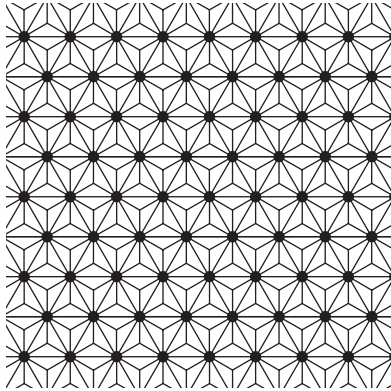

Chinese design

Q2 Code: _____

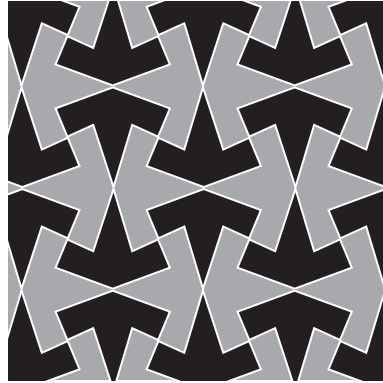

Moorish design

Q3 Code: _____

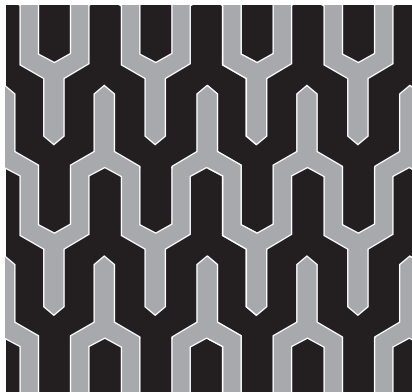

Arabian design

Q4 Code: _____

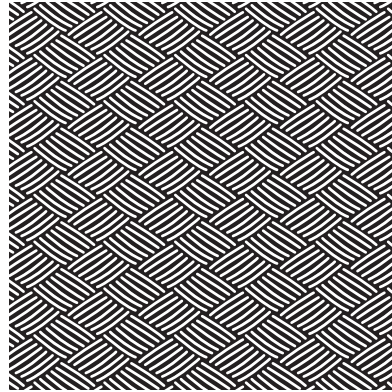

Assyrian design

Q5 Code: _____

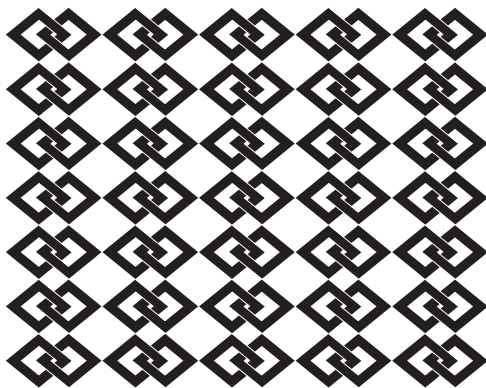

Japanese design

Q6 Code: _____

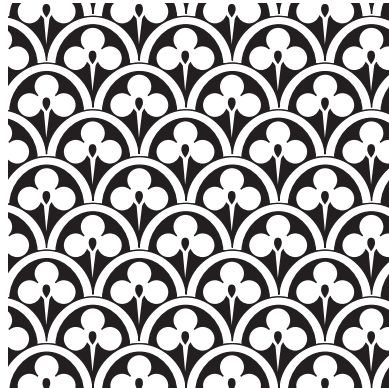

Indian design